

# WARON

BY GRS®



WATCH THE VIDEO



GRS® is proud to introduce the new Jura by GRS line of tools for stone setters, engravers and jewellery artists. This is a perfect collaboration between innovation and quality manufacturing. World-renowned diamond setter, Jura has made his name with precise setting and unimaginably complex designs. He has faced the challenges unique to stone setting and designed innovative solutions to overcome them. Jura's system is ergonomically suited for long hours at the bench and creates an environment for maximum efficiency.

**These tools will revolutionise your workflow!**

## C O N T E N T S

CLASSIC QUICK CHANGE SYSTEM **2**

3X LINE **12**

JURA BENCH **18**

JURA MUST HAVES **19**

JURA ORGANISERS **20**

JURA SMALL GOODS **22**

ACCESSORIES **23**

HOW TO COMBINE JURA WORKHOLDING:

- MICROBLOCK® / MICROBLOCK® XL **24**
- STANDARD BLOCK **25**
- 3X VICE **26**

DEALER DIRECTORY **28**



# CLASSIC QUICK CHANGE SYSTEM

**QC FIXTURE TABS SLIDE EASILY INTO JURA MASTER JAWS**



*CHANGE YOUR WORKHOLDING QUICKLY AND EFFICIENTLY*

## **GRS® MicroBlock® Vice (003-683)**

Also available: with MicroBlock® XL (#003-773),  
Adapter for GRS® Standard Block (#500-008).

## **Classic QC Workholding Fixtures (pp. 8-11)**

Shown: 6 mm Cylinder  
Top (#500-001).

## **Jura Master Jaws**

Connect multiple Classic  
QC fixtures. Compatible  
with MicroBlock® and  
MicroBlock® XL.

**WATCH THE VIDEO**



*"If I can hold it, I can set it."*

*— Jura*



**CLASSIC QC CLAMPS**  
*for horizontal fixtures*



**20 MM  
ROUND TOP**



**OUTSIDE  
RING HOLDER**

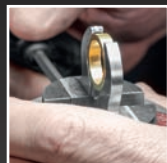

**SHELLAC  
PLATE**

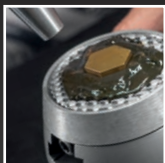

**DRILL HEAD  
HOLDER**



**FLAT  
CLAMPS**



# QC Basic Set

with MicroBlock®



500-508

The Basic Set is ideal for artists working with rings. It utilises the Jura Master Jaws and Quick Change (QC) fixtures to create a system that has been designed for ultimate work efficiency. The QC approach allows you to switch fixtures in just seconds. The Horizontal Ring Holder (combination of the Horizontal Ring Clamps #500-010 and the Inside Ring Holder Screw Set #500-011) has an independent locking system, allowing separate tension adjustments for the collet and the rotation of the ring. The Vertical Ring Holder is a simple and effective vertical ring solution. Ten expandable collets ensure finding the correct size for your work (Sizes 13–22 mm). A grooved set of flat clamps will hold practice plates and other flat items both square and round. They can also be used for holding beading tools for polishing and sharpening.

**Includes:**

- #003-683 MicroBlock®
- #500-018 Jura Master Jaws
- #523-017 Small Stackable Vice Base
- #523-020 5 mm Hex Key
- #500-007 Flat Clamps

- #502-501 Vertical Ring Holder
- #500-010 Horizontal Ring Clamps
- #500-011 Inside Ring Holder Screw Set
- #500-504 10 Plastic Collets
- #500-523 Organiser for QC Basic Set

*Also Available:*

**Without MicroBlock®** 500-509 

**For GRS® Standard Block** 500-512 

**With MicroBlock® XL** 500-526 

order 

WATCH THE VIDEO



# QC Complete Set

with MicroBlock®



500-510

Also Available:

**Without  
MicroBlock®**

500-511



**For GRS®  
Standard Block**

500-513



**With  
MicroBlock® XL**

500-527



order

The Complete Set expands upon the Basic Set and includes an amazing assortment of workholding solutions for any stone setter. Specialised clamps are ideal for uniquely-shaped projects, including rings, pendants, earrings, burr sharpening, drill making and beading tool sharpening. Grooved jaws allow you to quickly remove the workpiece and resharpen beading tools in one fixture. Each jaw can be customised using Thermo-Loc® for production-style setting. Brass points can be customised to hold a variety of objects, including spherical items. Shellac and Thermo-Loc cylinders provide support for fragile ring work.

## Includes:

#003-683 MicroBlock®

#500-018 Jura Master Jaws

#523-017 Small Stackable Vice Base

#523-020 5 mm Hex Key

#500-007 Flat Clamps

#502-501 Vertical Ring Holder

#500-009 Outside Ring Holder

#500-001 6 mm Cylinder Top

#500-002 10 mm Cylinder Top

#500-003 20 mm Round Top

#500-004 20 mm Straight Top

#500-005 40 mm Straight Top

#500-006 Engraver's Clamps

#500-013 Thermo-Loc® Engraver's Clamps

#500-014 Shellac Plate

#500-010 Horizontal Ring Clamps

#500-011 Inside Ring Holder Screw Set

#502-502 Thermo-Loc Cylinder

#502-015 Shellac Cylinder

#500-506 Tapered Point Holders

#500-507 Tapered Ball Holders

#500-504 10 Plastic Collets

#500-523 Organiser for QC Basic Set

#500-524 Organiser for QC Complete Set

#523-012 Organiser for Tapered Holders & Cylinders

#523-013 Organiser for Shellac Plate & Thermo-Loc Clamps

# QC Advanced Set

with MicroBlock®



500-517

order 

The Advanced Set is the most complete workholding system on the market. Jura has designed workholding solutions for almost any job. This system saves the user from the time and frustration of figuring out how to properly hold a piece for setting or jewellery engraving. In addition to workholding solutions, this set includes a variety of useful accessories. The hand chucks are perfect for use with beading tools, Jura's way stone pushers, burnishers, bead splitters and more. The digital divider and ceramic scribe are useful for precision layout. Tweezers and a carbide pick are great accessories that will serve many purposes in your daily work.

## ***Includes:***

- #003-683 MicroBlock®*
- #500-018 Jura Master Jaws*
- #523-017 Small Stackable Vice Base*
- #523-020 5 mm Hex Key*
- #500-007 Flat Clamps*
- #502-501 Vertical Ring Holder*
- #500-009 Outside Ring Holder*
- #500-001 6 mm Cylinder Top*
- #500-002 10 mm Cylinder Top*
- #500-003 20 mm Round Top*
- #500-004 20 mm Straight Top*
- #500-005 40 mm Straight Top*
- #500-006 Engraver's Clamps*
- #500-013 Thermo-Loc® Engraver's Clamps*
- #500-014 Shellac Plate*
- #500-010 Horizontal Ring Clamps*
- #500-011 Inside Ring Holder Screw Set*
- #502-502 Thermo-Loc Cylinder*
- #502-015 Shellac Cylinder*
- #500-506 Tapered Point Holders*
- #500-507 Tapered Ball Holders*
- #500-501 Drill Head Holder*
- #500-504 10 Plastic Collets*
- #500-521 10 Hand Chucks*
- #523-021 Digital Divider*
- #523-001 Tweezers*
- #523-005 Ceramic Scribe and Carbide Pick*
- #500-523 Organiser for QC Basic Set*
- #500-524 Organiser for QC Complete Set*
- #523-012 Organiser for Tapered Holders & Cylinders*
- #523-013 Organiser for Shellac Plate & Thermo-Loc Clamps*
- #523-014 Organiser for Hand Chucks*





**Vertical Ring Holder &  
Plastic Collets**

Included with all Classic QC  
Sets; plastic collets sold  
separately starting on page 22.

WATCH THE VIDEO

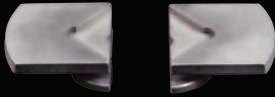

## Flat Clamps

500-007



Used for holding practice plates and flat workpieces in square, oval and round shape. The groove in the centre enables workpieces  $\varnothing$  2 mm and larger to be held vertically.



## Vertical Ring Holder

502-501



Use with collets #500-504, #502-504, #500-012 to hold rings and round watch bezels vertically.



## Outside Ring Holder

500-009



A simple and efficient ring clamp. Great for focusing on a smaller portion of the piece or small jobs inside the ring.

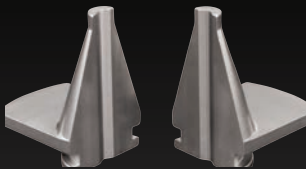

## 6 mm Cylinder Top

500-001



Ideal for making tools, holding small workpieces, and more. The conical shape is also great for use with Thermo-Loc® to make special clamps. The groove in the centre enables workpieces  $\varnothing$  2 mm and larger to be held vertically.

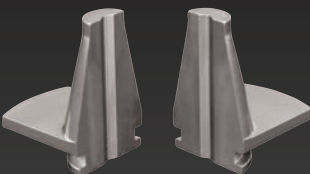

## 10 mm Cylinder Top

500-002



Good for clamping small workpieces such as stud earrings. The groove in the centre enables workpieces  $\varnothing$  2 mm and larger to be held vertically.



## 20 mm Round Top

500-003



Designed to hold rings, round pendants, and more. The groove in the centre enables workpieces  $\varnothing$  2 mm and larger to be held vertically.

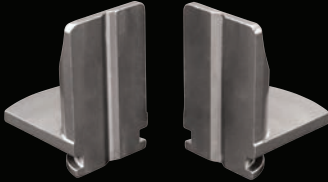

## 20 mm Straight Top

500-004



Universal mid-sized clamps for holding various types of workpieces. The groove in the centre enables workpieces  $\varnothing$  2 mm and larger to be held vertically.

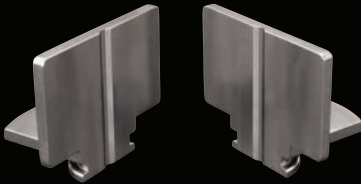

## 40 mm Straight Top

500-005



Universal large clamps for holding various types of larger workpieces. The groove in the centre enables workpieces  $\varnothing$  2 mm and bigger to be held vertically.



## Engraver's Clamps

500-006



A set of vice jaws made specifically for the Jura Master Jaws. This allows the artist to switch back quickly to a traditional set of vice jaws without having to unthread. The pin hole measure is 2.35 mm, allowing old burrs to be used as pins. The groove in the centre enables workpieces  $\varnothing$  2 mm and larger to be held vertically.

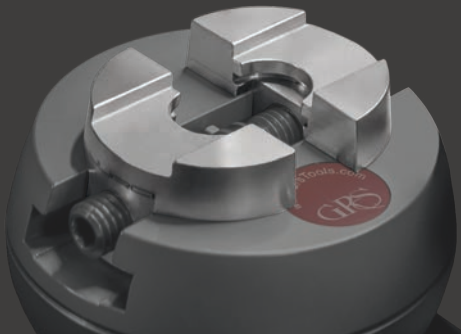

## Jura Master Jaws

500-018



Jura Master Jaws are the key to using Classic QC workholding fixtures. The jaws feature a unique shape that allows fixtures to slide in and out quickly and create maximum stability. They replace the standard jaws in GRS® MicroBlock® or MicroBlock® XL.

WATCH THE VIDEO

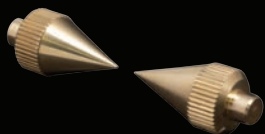

## Tapered Point Holders

500-506



Easily customised to create precise tension points on your work.

*For use in Horizontal Ring Clamps (#500-010).*

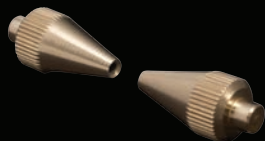

## Tapered Ball Holders

500-507



Ideal for holding spherical and circular pieces.

*For use in Horizontal Ring Clamps (#500-010).*



## Shellac Cylinder

502-015



Use with Shellac to hold rings.

*For use in Horizontal Ring Clamps (#500-010).*



## Thermo-Loc® Cylinder

502-502



Use with Thermo-Loc to hold rings.

*For use in Horizontal Ring Clamps (#500-010).*

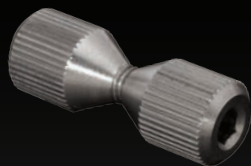

## Inside Ring Holder Screw Set

500-011



Inside Ring Holder Screw Set uses independent tension to expand collets (#500-504; #502-504; #500-012) while holding rings and round watch bezels. Collets not included.

*For use in Horizontal Ring Clamps (#500-010).*



# Horizontal Ring Clamps

500-010



Horizontal Ring Clamps are a key component of the Classic QC sets. They hold workpieces horizontally when paired with the Brass Tapered Holders, Shellac Cylinder, Thermo-Loc Cylinder, and Inside Ring Holder Screw Set.



## Thermo-Loc® Engraver's Clamps

500-013



Use with Thermo-Loc to hold a variety of uniquely-shaped pieces.



## Shellac Plate

500-014



Use with shellac to hold unusually-shaped pieces. The unique texture of the fixture helps to secure the shellac while working.

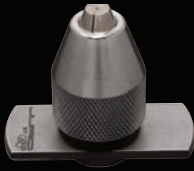

## Drill Head Holder

500-501



Use this vertical chuck to custom-make items such as beading tools, drills, and more. Also great for holding workpieces such as stud earrings and ear pins. Can hold small cylinders up to Ø 8 mm.



## Inside Engraving Ring Holder

500-503



This unique fixture holds rings from the outside, allowing easy access to the inside for engraving. Three thumb screws quickly secure the ring in place and specialised clamps allow the work to be rotated when the vice jaws are loosened.

WATCH THE VIDEO



## Adapter for GRS® Standard Block

500-008



Utilise the entire Classic QC Workholding System in your GRS Standard Block. Quickly drops into the pin holes of your Standard Block.

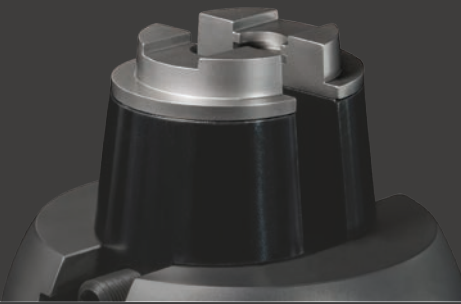

# JURA 3 X LINE

X-AXIS

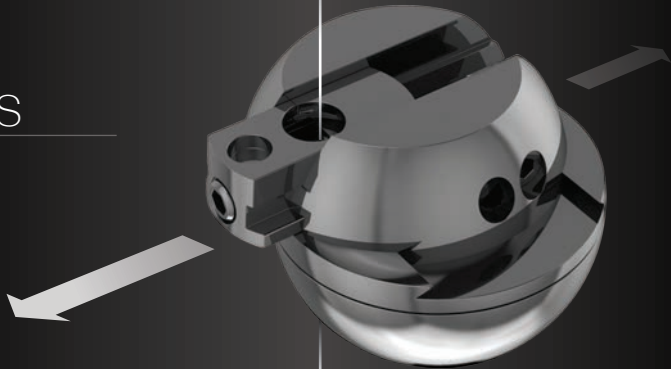

Y-AXIS



Z-AXIS

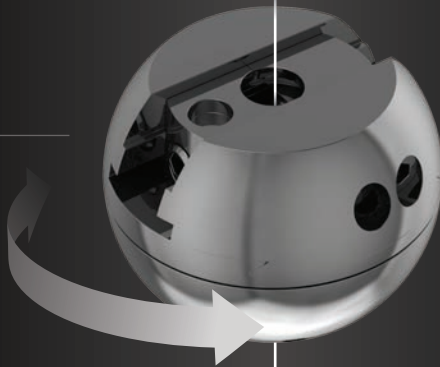

# STAY CENTRED

*THE 3X VICE IN COMBINATION WITH  
3X HOLDER BECOMES A 6-AXIS VICE!*

WATCH THE VIDEO



**3X Holder**  
adds three  
additional axes.

**3X Master Jaws**  
moves on X-axis.

**3X Vice**  
The upper part  
moves on the  
Y-axis and rotates  
on Z-axis.



# 3X LINE SET

WATCH THE VIDEO



## 3X Starter Set

502-516

order

The 3X Starter Set is one of the most innovative workholding solutions to hit the jewellery industry. By creating a multi-axis approach, your work will never be out of centre again. This system utilises movement in every direction to ensure unlimited access. For setters using a microscope, this product will save time and frustration. The set comes with the 3X Holder which allows the user to pivot and manipulate the workpiece to the exact position desired. The Orbital Holder (Orbital Jaws and Orbital Ball) creates additional versatility for QC and 3X attachments. Robust brass collets will ensure sturdy holding of rings. Jura Stackable Bases will keep work at a proper height depending on the attachment.

### *Includes:*

- 3X Vice*
- 3X Holder*
- 3X Master Clamps*
- #523-032 Set of Jura Stackable Bases*
- #523-020 5 mm Hex Key*
- #523-049 Orbital Jaws*
- #523-034 Orbital Ball*
- #523-033 M6 Screw*
- #500-504 10 Plastic Collets*
- #502-504 11 Brass Collets*
- Radius Divider*





## Flat Clamps with Pin Holes 502-078

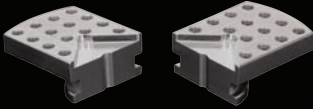

Used for holding practice plates and flat workpieces in square, oval and round shape. This fixture is an adapted version of Flat Clamps (#500-007) for use with the 3X Vice. Accommodate larger pieces by placing pins in the holes. The pin holes measure 2.35 mm. The groove in the centre enables workpieces Ø 2 mm and above to be held vertically.

## 3X Thermo-Loc® Clamps 502-518



Utilise the 3X System while holding irregular-shaped pieces. Designed to help keep Thermo-Loc in place and your work secure.

## Shellac Tubes

502-506



Shellac Tubes are dropped into the 3X Master clamps or 3X Holder to hold small pieces such as stud earrings, pendants, or other items. The ability to use two shellac tubes at a time allows for greater efficiency. Available in four sizes to save time heating.

*Includes: (1) 39 mm tube, (2) 20 mm tubes, (2) 15 mm tubes, (2) 11 mm tubes.*

WATCH THE VIDEO



## Aluminium Adapter Block 500-545

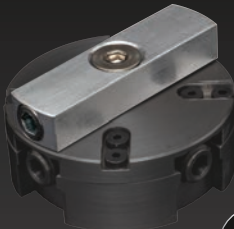

Turn the 3X workholding fixture into a tool that can be used in standard vice jaws. The Aluminium Adapter Block can be attached using the threads on the bottom of the 3X fixtures (see the table on pp. 24–25), allowing them to be clamped in any vice.

WATCH THE VIDEO





## Mini Chuck

502-505



Remain efficient during the work process with this great little drop-in attachment for making tools or holding work chuck-style. Can hold small cylinders up to  $\varnothing$  3 mm.

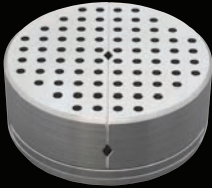

## Pin Vice

502-507



By using the traditional design of a pin vice and adding the 3X System approach, the user can clamp their workpiece and keep it centred while also being able to tilt and rotate the pin vice. The pin holes measure 2.35 mm.

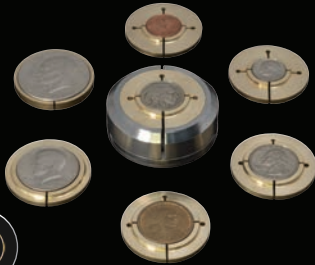

## Hobo Nickel Holder

502-508



The Hobo Nickel Holder uses a unique brass collet system that has been designed specifically for the most popular coins artists work with. The outer portion of the vice provides a sturdy clamping system to reduce vibration. Includes collets for Penny, Dime, Nickel, Quarter, Dollar, Half Dollar, Eisenhower Dollar.

*Coins not included*



## Replacement Orbital

500-546



Avoid time spent switching the Orbital Balls from one fixture to another by adding these replacement balls to fixtures you use regularly in the Orbital Jaws (#523-049).

# Orbital Jaws

523-049



The Orbital Jaws in combination with the Orbital Ball create extra versatility for your work. By attaching them to the Classic QC and 3X Line fixtures, the artist is able to tilt and simultaneously rotate the workpiece, keeping the work area centred under the microscope.



## 3X Shellac Plate

502-082



Secure your work using shellac and take advantage of the benefits of using the 3X System.

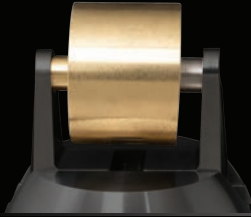

## Watch Bracelet Fixture

523-520



This cylindrical fixture provides a great workholding solution for setting and engraving watch bands. Can also be used for holding tennis bracelets or other flexible bracelets and large flat chains.



## 4-Jaw Chuck

502-509



This robust and versatile fixture is the ultimate holding option for uniquely-shaped items. Four independent jaws can be adjusted in a variety of different configurations to hold your work securely. The pin holes measure 2.35 mm.



## Watch Bezel Collets

500-012



These collets are specially designed to hold a variety of watch bezel sizes. Includes eight double-sided collets: 21–23 mm, 22–24 mm, 25–27 mm, 26–28 mm, 29–31 mm, 30–32 mm, 33–35 mm, and 34–36 mm.

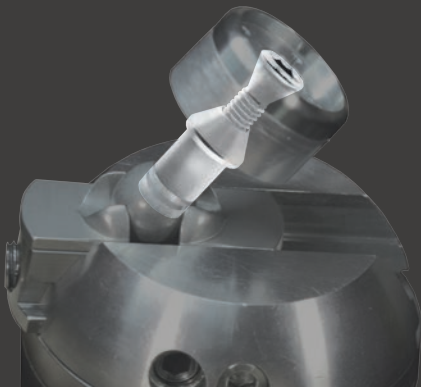

*TO USE THE COLLETS #500-504, #502-504, #500-012 WITH THE ORBITAL HOLDER SIMPLY CONNECT THEM VIA THE 3X HOLDER SCREW AND CYLINDER AND ENJOY IMPROVED ACCESSIBILITY TO YOUR WORK.*

*3X Holder not sold separately, included in the 3X Starter Set (#502-516).*

# Jura Microscope Stand

A sturdy and simple solution for holding Meiji or Leica® microscopes. This stand can be set at the desired height and then easily swung to the side for work that does not require a microscope. The model for use with a Meiji microscope comes with a focus drive with an internal diameter of 84 mm. The Leica model works with the mounting pin (15 mm) on the back of the Leica A60.



**For Meiji**

502-023



**For Leica®**

502-032



# Camera Mount

502-024



This style of camera mount for microscope with built-in focus block is an ideal solution for videoing work or sharing your process on a monitor. Fits 84 mm microscopes. Camera not included.



# Vacuum System

500-502



This telescoping system saves precious metals and promotes a healthier work environment by removing small particles from the bench. It works with many different styles of vacuum systems (vacuum not included). It collapses when not in use to save space. Mounted on the back panel of the workbench; recommended back panel thickness 22 mm.

# Jura Stackable Vice Bases

WATCH THE VIDEO



523-032



**Set of 3**

Set of three bases are designed to keep work at a consistent height, depending on which Jura fixture you are using. They are stackable and sturdy. Recommended use of thin rubber or leather on the top and bottom for maximised control. This set of 3 stackable bases is included with the 3X Starter Set (#502-516).

Also Available Individually:

**Small**

523-017



**Medium**

523-018



**Large**

523-019



## Digital Divider

523-021

This compact digital divider is great for precise layout. The hardened steel jaws can be sharpened to your desired points and have a maximum opening of 37.6 mm. Sold preshaped, not sharpened.



## 5 mm Hex Key

523-020

















This large handle 5 mm hex key is great for getting extra leverage when tightening down your vice jaws.





## JURA ORGANISERS

Turn your workbench into an ergonomic space and keep your tools handy with our range of Jura Organisers:

	<b>For Classic QC Basic Set</b>	500-523	
	<b>For Classic QC Complete Set</b>	500-524	
	<b>For Small Goods</b>	523-011	
	<b>For Tapered Holders &amp; Cylinders</b>	523-012	
	<b>For Shellac Plate &amp; Thermo-Loc® Clamps</b>	523-013	
	<b>For Hand Chucks</b>	523-014	
	<b>For Digital Calliper</b>	523-015	
	<b>For Digital Divider</b>	523-029	



## Stone Organiser

502-514



Keep your stones organised and in one place. Forty smaller square boxes allow you to create your own organisation system within a larger box.



## Colored Stone Trays

500-522



A set of six colored trays are perfect for separating different stone sizes and staying organised. They are stackable for space savings and designed to easily access your stones.



## Micromotor Handpiece Stand

500-525



Keeping your micromotor within reach and off the bench top makes the holder a great addition to your bench.



## Tweezers

523-001



An ideal solution for picking up drills, burrs, or other small items.



## Plastic Collets

500-504



Replacement set of plastic collets. Fits Classic QC system and 3X Line. This set of 10 collets is for rings sized 13–22 mm.



## Brass Collets

502-504



This set of 11 brass collets is perfect for use with Classic QC ring fixtures and 3X Line. Durable construction will withstand hammering. It also includes a radius divider for quick and easy layout. Ideal for microbands, fishtail and multi-sided setting.



## Hand Chucks

500-521



### 10-piece Round & Stub Head Set

Hand chucks are great for use with beading tools, Jura's way stone pushers, bead splitters, burnishing tools, and more. The half-round handles provide a great reference point when using beading tools. The round handles are ideal for burnishers and bead splitters.



## Ceramic Scribe & Carbide Pick

523-005



This set of tools is great for doing layout and positioning stones. The ceramic scribe doesn't catch on metal like traditional scribes. The carbide pick can have many uses such as moving or adjusting stones.

*Also Sold Individually:*

### Ceramic Scribe

523-006



### Carbide Pick

523-004





# ACCESSORIES



## C-Max Round Blank

022-393



Industry-leading carbide gravers.

Length: 45 mm. Use with Classic QC. Ø 2.35 mm

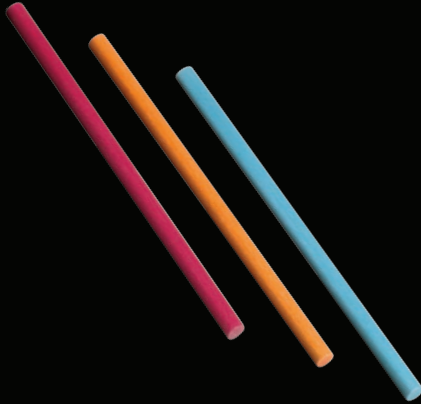

## Ceramic Polishing Stones

For use in micromotor handpiece when polishing and finishing. Round Ø 2.35 mm x 50 mm.

**1200 Grit, Red** 602-422



**1000 Grit, White** 602-423



**800 Grit, Blue** 602-424



**600 Grit, Black** 602-425



**400 Grit, Orange** 602-426



**300 Grit, Light Brown** 602-427



**220 Grit, Grey** 602-428



## Thermo-Loc®

Thermo-Loc softens with heat to a pliable clay-like consistency that you can form around your work. At room temperature, it hardens and holds anything from firearms to wood securely. Developed to hold irregularly shaped or fragile items. Non-toxic, biodegradable.

**Thermo-Loc, 225 g** 003-664



**Thermo-Loc, 450 g** 003-665



**Thermo-Loc, 2.25 kg** 003-666



# HOW TO COMBINE JURA WORKHOLDING

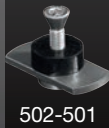
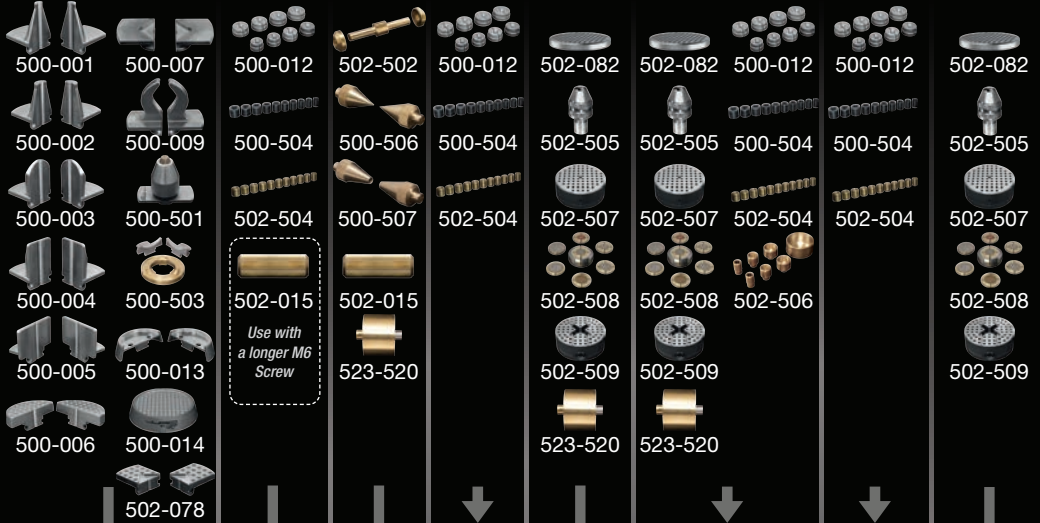

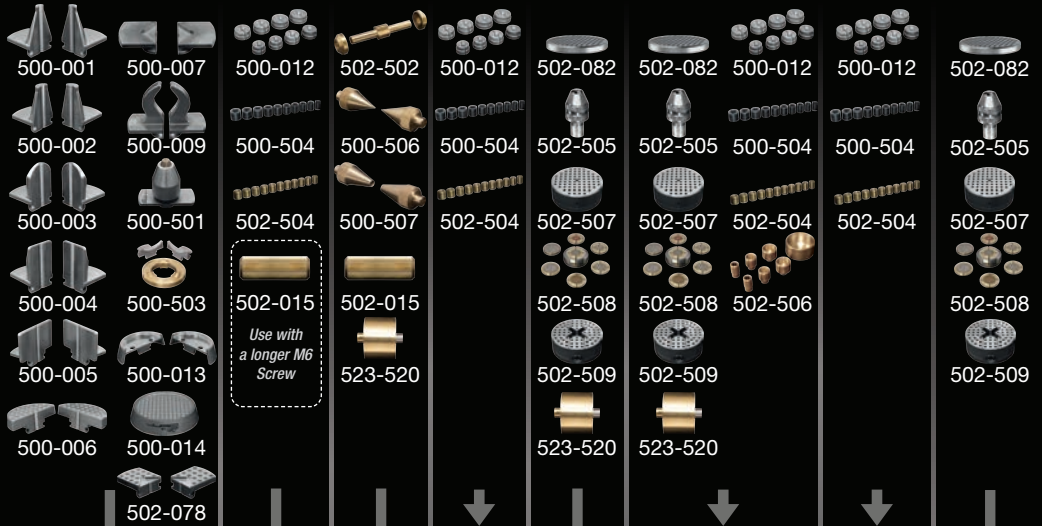

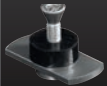
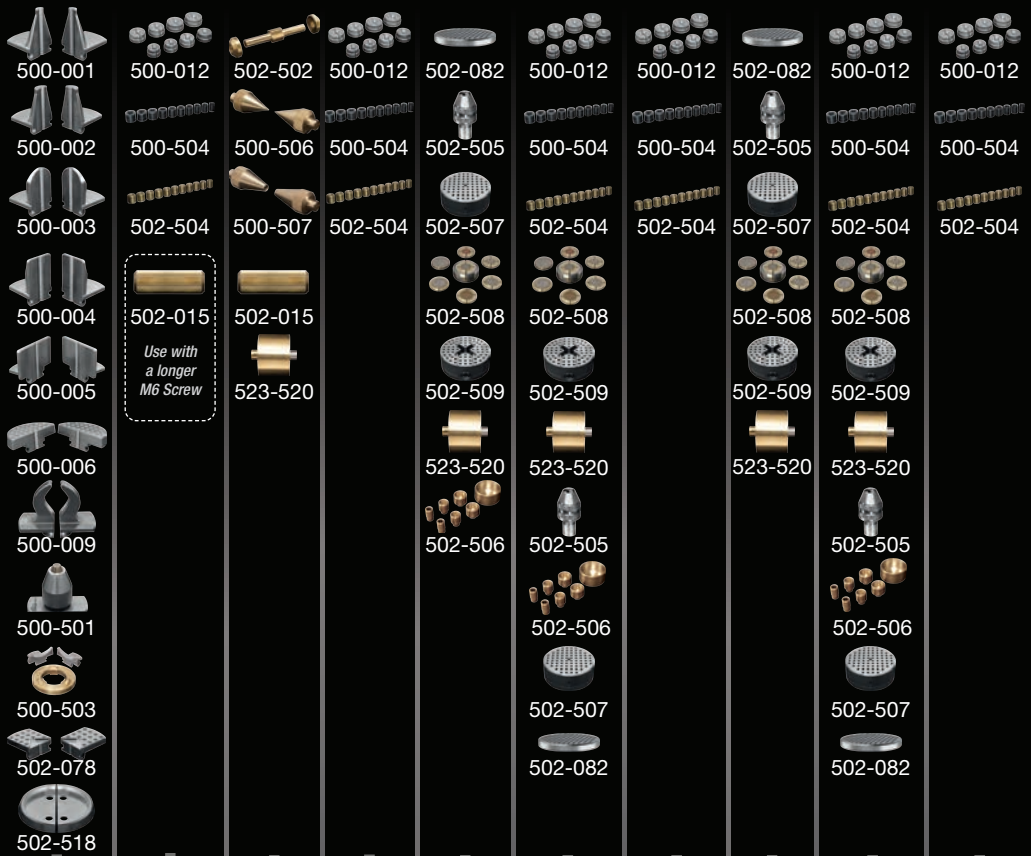



**4-Jaw Chuck**

Shown in combination with  
the 3X Holder, 3X Clamps  
and 3X Vice.

# DEALER DIRECTORY

Austria 1:

**Felber's Nachfolger**

Siebensterngasse 30  
1070 Vienna  
Phone +43 1 523 24 73-0  
www.j-felber.at

Austria 2:

**Felber's Vertriebspartner  
Günter Baumgartner**

Auergasse 9  
6170 Zirl  
Phone +43 664 535 6770  
www.j-felber.at

Belgium:

**Alexandre BVBA**

Appelmansstraat 25-27  
Empire Shopping Center  
2018 Antwerp  
Phone +32 3 213 00 39  
www.alexandreschool.com

Cyprus:

**B.J.P - Panagiotidou Elli &  
Sia Epe**

Villara 1  
54625 Thessaloniki  
Phone +30 2310555270  
www.bjp.gr

Czech Republic:

**Advantage-fl.cz s.r.o.**

Soukenická 11  
11000 Prague 1  
Phone +420 605 216 756  
www.advantage-fl.cz

Denmark:

**Aktiv Guld A/S**

Vallensbækvej 46  
2625 Vallensbæk  
Phone +45 43 66 20 00  
www.aktivguld.com

Finland:

**K.A. Rasmussen Oy**

Eteläranta 14  
00130 Helsinki  
Phone +358 10 337 50 00  
www.rasmussen.fi

France 1:

**Tena Butty**

116, Chemin de Mialouze  
26130 Montsegur Sur Lauzon  
Phone +33 475 98 10 22  
www.tena-butty.com

France 2:

**TBRP Paris (Pouget Pellerin)**

15, rue de Montmorency  
75003 Paris  
Phone +33 1 42 74 44 11  
www.pouget-pellerin.com

France 3:

**Schwartzmann Fisseau Cochot**

12 rue Rene Payot  
25503 Morteau  
Phone +33 381 67 18 34  
www.schwartzmann.com

Germany 1:

**Rudolf Flume Technik GmbH**

Hachestraße 66  
45127 Essen  
Phone +49 201 1899-0  
www.flume.de

Germany 2:

**Horbach-Technik GmbH**

Hauptstraße 139 A  
D-55743 Idar-Oberstein  
Phone +49 6781 45897-0  
www.horbachtechnik.de

Greece:

**B.J.P - Panagiotidou Elli & Sia Epe**

Villara 1  
54625 Thessaloniki  
Phone +30 23105 55270  
www.bjp.gr

Iceland:

**Handverkshúsið**

Rauðagerði 25  
108 Reykjavík  
Phone +354 555 12 12  
www.handverkshusid.is

Ireland 1:

**Betts Metal Sales Ltd**

49-63 Spencer Street  
Birmingham, B18 6DE  
Phone +44 121 233 2413  
www.bettsmetalsales.com

Ireland 2:

**Cooksongold**

59-83 Vittoria Street  
Birmingham, B1 3NZ  
Phone +44 345 100 1122  
www.cooksongold.com

Ireland 3:

**HS Walsh & Sons Ltd**

Hunter House, Biggin Hill  
Airport, Churchill Way,  
Biggin Hill, Kent, TN16 3BN  
Phone +44 1959 543660  
www.hswalsh.com

Italy 1:

**Luigi Dal Trozzo S.A.S.**

Via Claudio Treves 26  
20090 Vimodrone  
Phone +39 02 2885871  
www.luigidaltrozzo.it

Italy 2:

**Garbarino & Titonel srl**

Via del Lavoro 3  
15048 Valenza  
Phone +39 0131 924 264  
www.garbarinotitonel.com

Netherlands:

**Bijou Moderne B.V.**

Edisonlaan 36-38  
2665 JC Bleiswijk  
Phone +31 10 529 66 00  
www.bijoumoderne.nl

Norway:

**K.A.Rasmussen AS**

Postboks 4455  
2326 Hamar  
Phone +47 625 12 710  
karasmussen.com

Poland 1:

**W. Kociuba S.J.**

Ul. Rakowicka 1  
31-511 Krakow  
Phone +48 12 430 36 79  
www.wkociuba.pl

Poland 2:

**Firma Jubilerska**

**K. Brzuchowski**  
Ul. Hetmańska 20  
40-560 Katowice  
Phone +48 501 733 093  
brzuchowski.pl

Portugal:

**Maquinouro, Lda**

Rua Engenheiro Adelino  
Amaro da Costa 1144/44  
4420-005 Gondomar  
Phone +351 22 483 55 51  
www.maquinouro.pt

Russia:

**Jewellery Air**

Ul. Bumazhnaya, 17 / 109  
190020 St. Petersburg  
Phone +7 495 16 28 477  
www.jewelleryair.com

Slovakia:

**Advantage-fl.cz s.r.o.**

Soukenická 11  
11000 Prague 1  
Phone +420 605 216 756  
www.advantage-fl.cz

Spain:

**Chamorro y Moreno, S.A**

C/ Isla de Sicilia 1  
28034 Madrid  
Phone +34 91 315 20 49  
www.comrashop.es

Sweden 1:

**Sargenta AB**

Grenadjärgatan 14  
254 53 Helsingborg  
Phone +46 401 26 550  
www.sargenta.se

Sweden 2:

**Aktiv Guld AB**

Vallensbækvej 46  
2625 Vallensbæk  
Phone +46 22 27 80 100  
www.aktivguld.com

Switzerland:

**Artsupport GmbH**

Glattalstrasse 222  
8153 Rümlang  
Phone +41 44 818 18 18  
www.artsupport.ch

United Kingdom 1:

**Betts Metal Sales Ltd**

49-63 Spencer Street  
Birmingham, B18 6DE  
Phone +44 121 233 2413  
www.bettsmetalsales.com

United Kingdom 2:

**Cooksongold**

59-83 Vittoria Street  
Birmingham, B1 3NZ  
Phone +44 345 100 1122  
www.cooksongold.com

United Kingdom 3:

**HS Walsh & Sons Ltd**

Hunter House, Biggin Hill  
Airport, Churchill Way,  
Biggin Hill, Kent, TN16 3BN  
Phone +44 1959 543660  
www.hswalsh.com



**GRS**

*tools in Europe*

## OTHER COUNTRIES:

Albania, Algeria, Belarus, Bosnia and Herzegovina, Bulgaria, Croatia, Estonia, Hungary, Latvia, Libya, Lithuania, Luxembourg, Macedonia, Malta, Mauretania, Moldova, Montenegro, Morocco, Romania, Serbia, Slovenia, Tunisia, Turkey, Ukraine.

✉ [grseurope.com](http://grseurope.com)

✉ [info@grseurope.com](mailto:info@grseurope.com)

📱 [#grseurope](https://www.instagram.com/grseurope)

WORKHOLDING SOLUTIONS FROM THE MIND OF

JURCO



GRS<sup>®</sup>

*tools in Europe*

*The official European website about professional tools  
for stone setters, engravers and jewellers. For all your  
tools, training and support!*

grseurope.com  
info@grseurope.com